

FEELWORLD®

L2 PLUS

Multi-camera Video Switcher



User Manual

Contents

Chapter 1 Your Product	4
1.1 Product Overview	4
1.2 Key Features	4
1.3 Front Panel	5
1.4 Interface Panel	6
Chapter 2 Install Your Product	7
2.1 Plug in Power	7
2.2 Connect HDMI Input	7
2.3 Connect HDMI Output	8
2.4 Connect Microphone and External Monitoring Devices	8
2.5 Connect USB as a Network Signal Source	8
2.6 Connect Computer and L2 PLUS	9
2.7 Turn on Your L2 PLUS	9
Chapter 3 Use Your Product	10
3.1 Touch Screen	10
3.2 Main Menu	11
3.2.1 Input	11
3.2.2 HDMI	11
3.2.3 USB3.0	11
3.2.4 Audio	12
3.2.5 IP Setting	12
3.2.6 Settings	12
3.3 Function Menu	13
3.3.1 MIX	13
3.3.2 MODE	13
3.3.3 PIP	14
3.3.4 PTZ	14
3.3.5 LOGO Overlay	15
3.3.6 Chroma Key	15
3.4 Switch Source	16
Chapter 4 Streaming	17
4.1 OBS Streaming	17
4.2 vMix Streaming	21
Chapter 5 Feelworld Live Software Operation	23
5.1 Connect L2 PLUS and computer	23
5.1.1 Direct Link via a Network Cable	23
5.1.2 Static Direct Connection	24

5.1.3 Connect Wirelessly with Your Router	25
5.2 Using Feelworld Live	25
5.2.1 Input Info	27
5.2.2 HDMI	27
5.2.3 USB 3.0	27
5.2.4 Live Streaming	28
5.2.5 Audio	28
5.2.6 Test Pattern	29
5.2.7 HDMI Out Setting	29
5.2.8 Password Protection	29
5.2.9 Lan Port Set	30
5.2.10 Language	30
5.2.11 T-Bar Calibration	30
5.2.12 T-Bar Calibration	31
5.2.13 MIX	31
5.2.14 PIP	32
5.2.15 Chroma Key	32
5.2.16 PTZ Camera Setting	32
5.2.17 Logo Overlay	33
Chapter 6 Product Parameters	35

Thank you for choosing our product!

This User Manual is designed to show you how to use this video switcher quickly and make use of all the features. Please read all directions and instructions carefully before using this product.

Safety Instruction

The general safety information in this summary is for operating personnel.

1. There are no user-serviceable parts within the unit. Removal of the top cover will expose dangerous voltages. To avoid personal injury, do not remove the top cover. Do not operate the unit without the cover installed.
2. Please do not use chemical solutions to clean this product. Please wipe the switcher with a clean soft cloth to maintain the brightness of the surface.
3. This product comes with standard 12V/2A power adapter, please use the power supply correctly.
4. To avoid explosion, do not operate this product in an explosive atmosphere.

Installation Safety Summary

Safety Precautions

For all product installation procedures, please observe the following important safety and handling rules to avoid damage to yourself and the equipment. To protect users from electric shock, ensure that the chassis connects to earth via the ground wire provided in the AC power Cord. The AC Socket-outlet should be installed near the equipment and be easily accessible.

Unpacking and Inspection

Before opening product shipping box, inspect it for damage. If you find any damage, notify the shipping carrier immediately for all claims adjustments. As you open the box, compare its contents against the packing slip. If you find any shortages, contact your sales representative. Once you have removed all the components from their packaging and checked that all the listed components are present, visually inspect the system to ensure there was no damage during shipping. If there is damage, notify the shipping carrier immediately for all claims adjustments.

Site Preparation

The environment in which you install your product should be clean, properly lit, free from static, and have adequate power, ventilation, and space for all components.

Chapter 1 Your Product

1.1 Product Overview

FEELWORLD L2 PLUS, as a pocket-sized push-stream switcher, equipped with a 5.5-inch touch screen, supports real-time monitoring, special effects switching, live streaming, audio insertion, independent input format conversion, PTZ camera control based on VISCA protocol, Chroma key, LOGO overlay and other functions. L2 PLUS is able to control 8 PTZ cameras at the same time and do operations of Zoom In/Out. Meanwhile, L2 PLUS also supports not only Window and MAC operating systems, but also iOS and Android mobile phones for a wide range of fast operation.

1.2 Key Features

- USB3.0 fast to live streaming
- 4CH HDMI inputs
- 5.5-inch touch screen, easier operation
- Auto cut and manual switch (T-Bar)
- 15 transition effects, 9 layers PIP mode
- Audio offers AFV or Line In mode
- Supports to mix any 2 audios from HDMI 1~4 and LINE IN
- Supports switch between 6-Picture PVW and PGM to HDMI Out
- Control by Feelworld Live software
- Compact design
- Logo overlay
- Chroma Key
- PTZ control

1.3 Front Panel

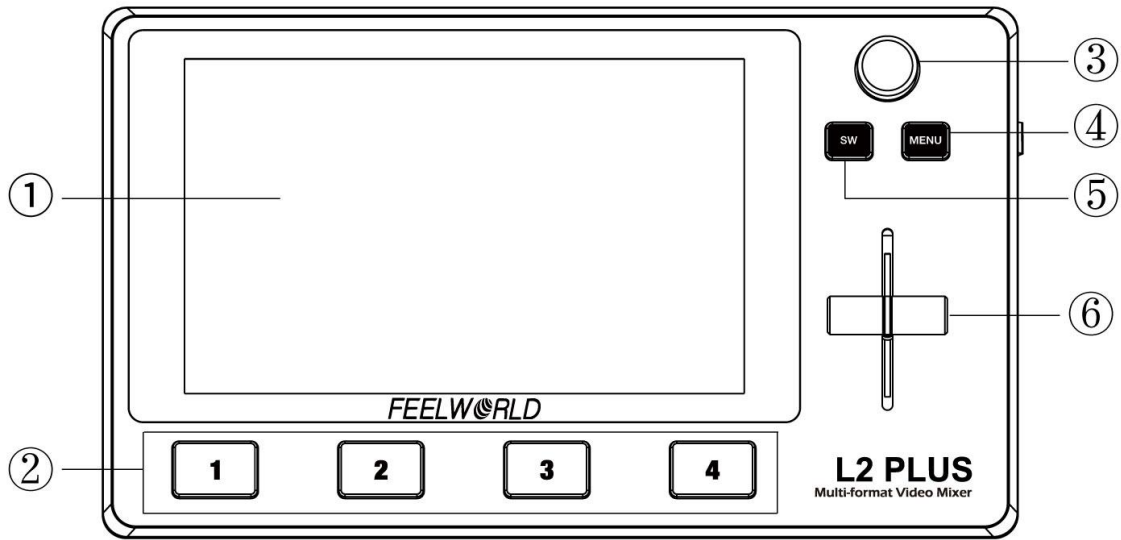

No.	Connectors	Description
1	LCD screen	5.5-inch touch screen for menu operation
2	Signal button	The lights on the signal source buttons will appear in four states: 1. red: is on air (PGM), 2. static green: signal is standing by, 3. flashing green: ready to be switched, 4. No light: input source is not supported
3	Knob	Turn knob to select menu item or adjust parameters, push to confirm
4	Menu	Main menu and back button
5	SW	Function menu
6	T-Bar	Manual switching, push to top end or bottom end to switch signal to PGM (Note: when t-bar not on top or bottom end, the signal cannot be switched)

1.4 Interface Panel

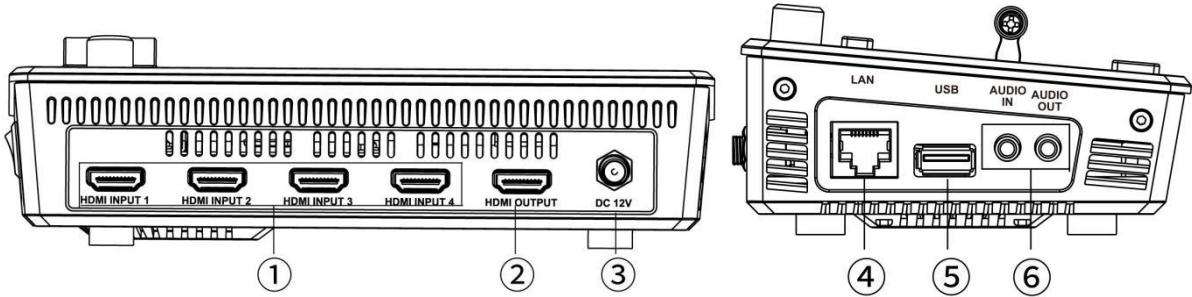

No	Connectors	Description
1	HDMI IN	4 HDMI Inputs, connect to input source from HD camera or PC
2	HDMI OUT	1 HDMI Output, connect to display to show Preview (6 pictures) or PGM.
3	DC 12V	1 DC Jack for power input, connect to 12V/2A power adapter.
4	LAN	Communication port to link dedicated software for control
5	USB	USB3.0 output, capture signal via third party streaming software and push to live broadcasting websites
6	AUDIO IN/OUT	AUDIO In, analog audio input port, connect to microphone AUDIO OUT, analog audio output port, connect to loudspeaker

Chapter 2 Install Your Product

2.1 Plug in Power

When linking the power supply, please check the power supply standard used in your country/region. If you are using a power supply that does not have a lock, please tighten the power connector of the device to ensure the stability of the L2 PLUS's power supply.

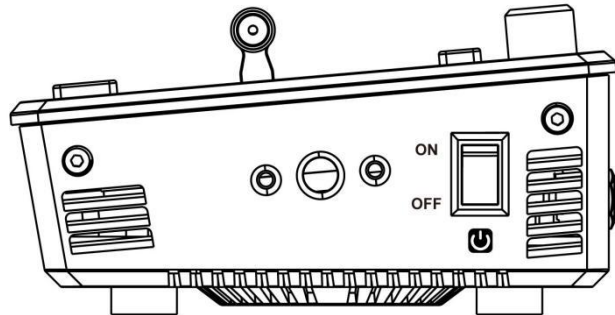

Turn on after linking to the power

2.2 Connect HDMI Input

You can use any camera, computer or other HDMI device as the input source of the L2 PLUS. It supports up to 1080P standard and 4 sources of different formats and resolutions at the same time.

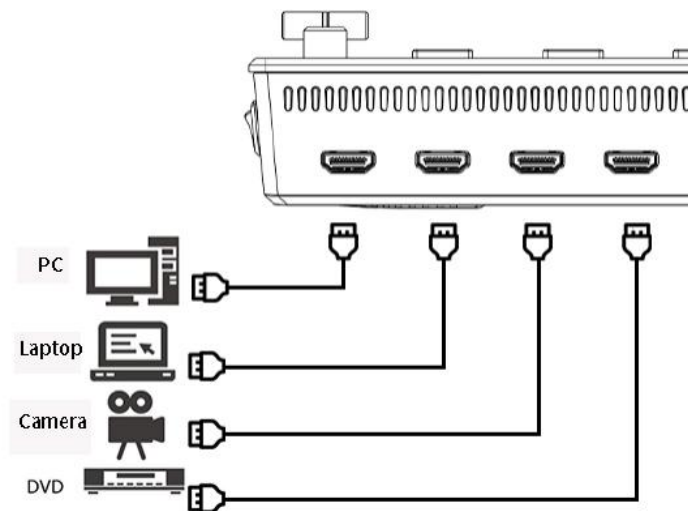

Connect the PC, camera and other input source to HDMI IN connector

2.3 Connect HDMI Output

In the L2 PLUS, you can choose to use HDMI output as the pre-monitoring interface to achieve 16:9 6-picture split pre-monitoring, and we also provide a preset function.

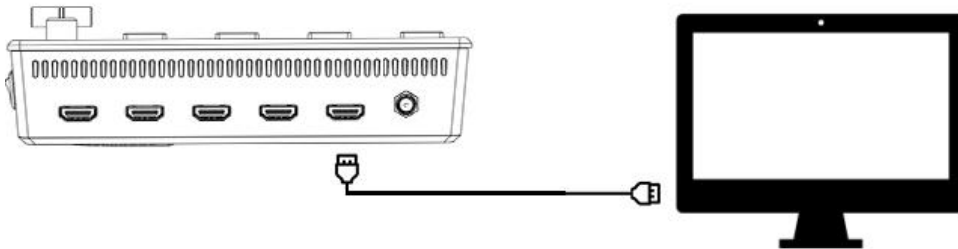

Connect LCD screen to L2 PLUS by HDMI cable to display 6-picture PVW.

2.4 Connect Microphone and External Monitoring Devices

On the left side of the L2 PLUS, a standard 3.5mm microphone jack is provided. The L2 PLUS supports the independent input of an active (self-powered) microphone device, allowing the L2 PLUS to collect sound information more clearly when it is used for interview programs. You can also use an external sound console to mix multiple external sound inputs.

The L2 PLUS also provides a standard 3.5mm audio output, so you can use external speakers or headphones to monitor the L2 PLUS's main output audio signal in real time.

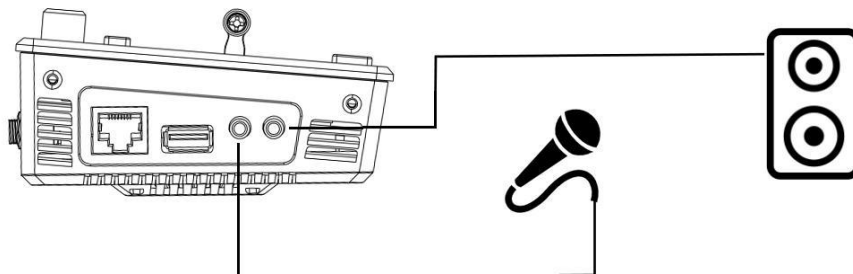

Connect microphone to Audio In and Loudspeaker to Audio Out

2.5 Connect USB as a Network Signal Source

You can use the L2 PLUS's USB port to use the L2 PLUS as a webcam source, and you can recognize the webcam signal from the L2 PLUS on live streaming platforms like Zoom, YouTube, Facebook, Twitch, OBS, etc.

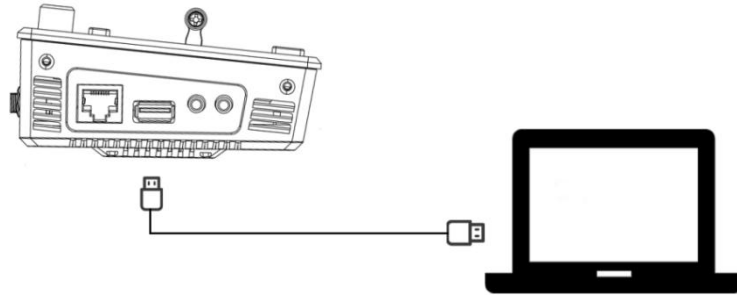

Note: If your computer only has a Type-C port, you can use a USB-A to Type-C cable to transmit the webcam signal. Please note that the Type-C cable you choose needs to support data transmission. The signal is recognized in Windows and MAC system as 「FEELWORLD」 .

2.6 Connect Computer and L2 PLUS

Software control: connect computer and L2 PLUS with CAT6 cable

Record and Stream: connect L2 PLUS's USB-A and L2 PLUS's USB 3.0 port with USB3.0 cable

(Note: the color of USB3.0 port is blue)

Minimum System Requirements for macOS (Note: the following system is an example, it doesn't mean only this system supported)

- macOS 11.0 Big Sur or later
- macOS 10.15 Catalina

Minimum System Requirements for Windows

- Microsoft Windows 10 64-bit

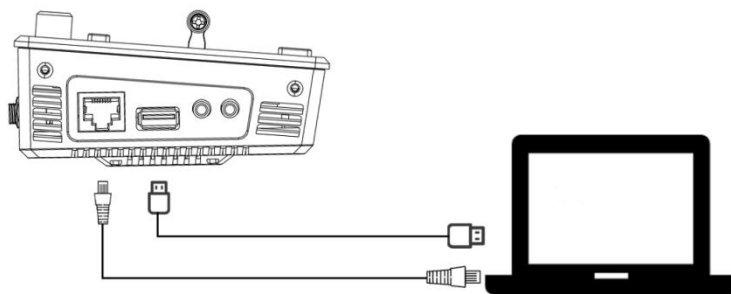

Note: The IP address of the L2 PLUS must be in the same WLAN segment as the computer.

2.7 Turn on Your L2 PLUS

The device will enter to the boot interface after turning on .



Chapter 3 Use Your Product

3.1 Touch Screen

On the front panel of L2 PLUS, you can see a 5.5-inch touch screen as shown in the picture below: The LCD screen presents 4 input sources, PST preview picture and PGM output picture. Gently press one of the four pictures on the screen to switch input signal; Long press any position of the screen to switch PGM as full screen; Long press again to return to six-picture preview; click PST preview can switch A/B layer.

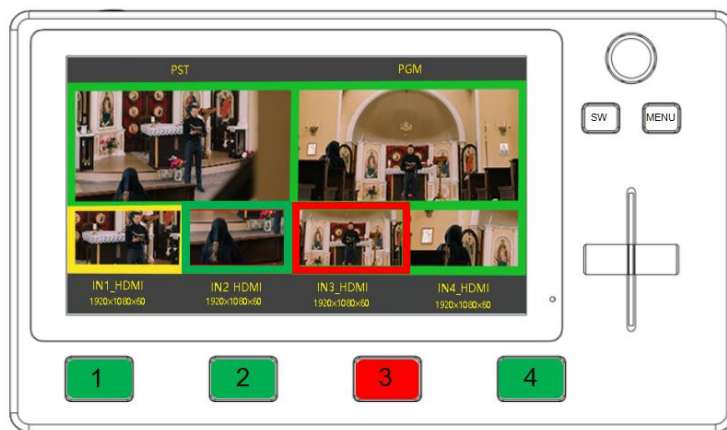

Gently press **【MENU】** / **【SW】** key to enter Main Menu or Function Menu, which will appear in the center on the LCD screen as shown in the picture .

The operation style of the screen is similar with that of the mobile phone. Gently touch the menu icon to enter the corresponding sub menu settings or turn the knob which on upper right corner of the front panel to select the menu.

Shortcut key SW+MENU brings up the volume setting menu, and rotate the knob to adjust the volume.



3.2 Main Menu

After L2 PLUS is powered on, press **【MENU】** button to enter the main menu which includes: Input, HDMI, USB 3.0, Audio, IP Setting and setting. Tap

 exit main menu

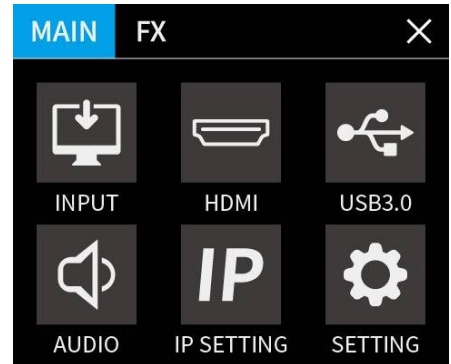

3.2.1 Input

Gently touch **【INPUT】** icon  to enter the sub menu

The input menu displays the information of the input signal source.

If there is no input source, it displays: NO INPUT

DEINTERLACE: ON/OFF (prevent the video/image with stripes)

Tap  return to main menu

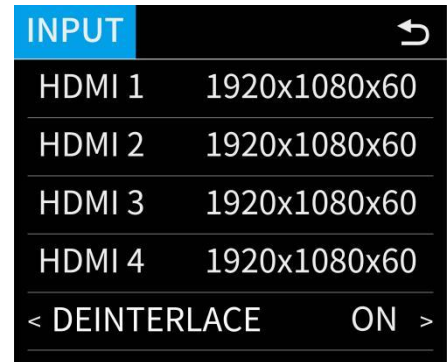

3.2.2 HDMI

Gently touch **【HDMI】** icon  to enter the sub menu

Select the output and format by touching screen or turning the knob.

LCD: PVW/PGM

OUTPUT: PVW/PGM

FORMAT: 1920x1080@60 (max)

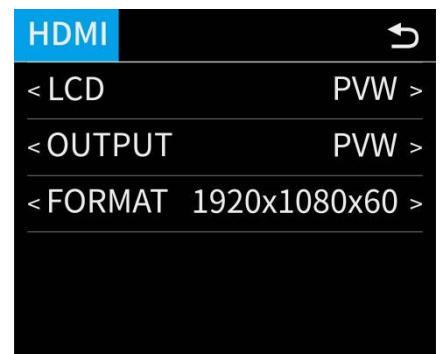

3.2.3 USB3.0

Gently touch **【USB 3.0】** icon  to enter the sub menu

Select the output and format by touching screen or turning the knob.

OUTPUT: PVW/PGM

FORMAT: 1920x1080@60 (max)

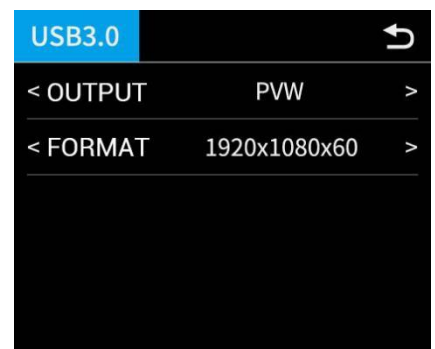

3.2.4 Audio

Gently touch **【AUDIO】** icon  to enter the sub menu

Selecting by touching screen or turning the knob.

VOLUME: 0~100

SOURCE: AFV/HDMI1~4/LINE IN

MIX: OFF/HDMI1~4/LINE IN

EXT TYPE: LINE IN/MIC

AUDIO BAR: ON/OFF

AUDIO	
< VOLUME	100 >
< SOURCE	HDMI 1 >
< MIX	HDMI 2 >
< EXT TYPE	LINE IN >
< AUDIO BAR	ON >

Note: For sound mixing function, you can select any 2 audios to mix from HDMI 1~4 and LINE IN

3.2.5 IP Setting

Gently touch **【IP SETTING】** icon  to enter the sub menu

SET IP Address Manually

Turn **OFF** DHCP and select **each segment** with the knob, then press to enter and set the **value** of each segment by pressing the knob again.

Set IP Address Automatically

Use this setting if your network/router has a DHCP server

Turn **ON** DHCP

manual setting is disabled, and the IP Address for L2 PLUS is set from the network.

IP SETTING	
192.168.255.255	
< DHCP	ON >

3.2.6 Settings

Gently touch **【SETTING】** icon  to enter the sub menu.

LANGUAGE: English/Chinese



FAN SPEED: 0~3

LCD BACKLIGHT: 1~100

MENU TIMEOUT: OFF/15S/30S/45S/60S

RESET: NO/YES

DEVICE SN: device serial number

SETTING	 
< LANGUAGE	ENG >
< FAN SPEED	3 >
< LCD BACKLIGHT	80 >
< MENU TIMEOUT	30S >
< RESET	OFF >

3.3 Function Menu

Press **【SW】** button to enter the function menu which includes: MIX, MODE, PIP, PTZ, LOGO and CHROMA KEY.
Press **【SW】** button to exist the function menu.

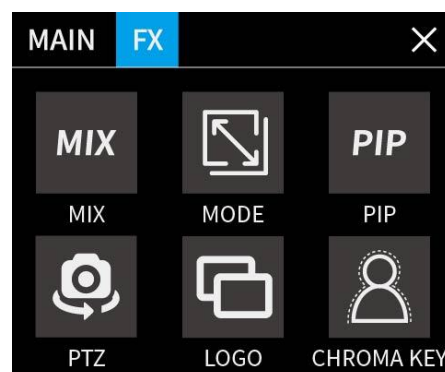

3.3.1 MIX

On<**MIX**> menu, there are 15 kinds of effects to choose.

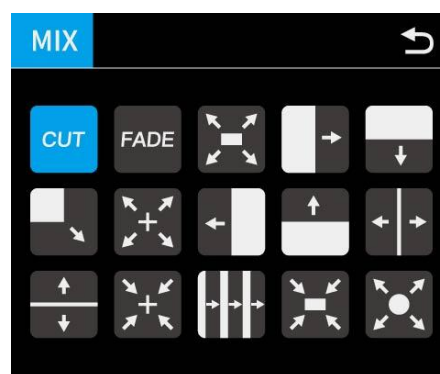

Note: In actual use, the hard cut is only available in **Quick Cut** mode, if you use **T-Bar** mode, it will automatically change to **FADE**.

3.3.2 MODE

There are 2 transition modes: **FAST** or **T-BAR**
Switching time: **0.5s ~ 5.0s**



Note: In **T-Bar** mode, you can directly control the progress of the T-Bar manually and customize the switching.

3.3.3 PIP

Push【SW】button to enter <PIP> menu and select PIP mode(9 PIP modes). The steps are as follows:

1. Select the signal (input 1/2/3/4) you want for **main picture**.
(A)
2. Select the PIP layout you need.
3. Press the input signal button(1/2/3/4) to select the **sub-picture(B)**
4. Push the T-Bar and the content you've set will be taken to PGM.

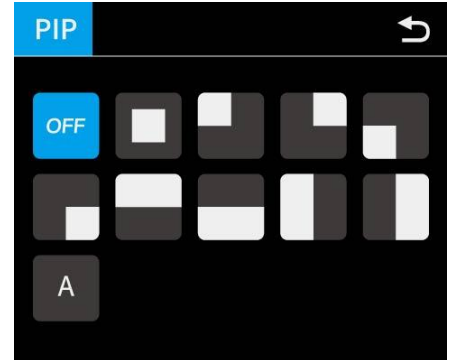

Note: T-bar has to be totally left or right side to make sure the content has been taken

How to Switch Main/Sub Picture Quickly

Switch main-picture:

1. Touch **Main-picture** on PST screen
2. Directly touch one of the four inputs, which will replace as main-picture.

Switch sub-picture:

1. Touch **Sub-picture** on PST screen
2. Directly touch one of the four inputs, which will replace as sub-picture.

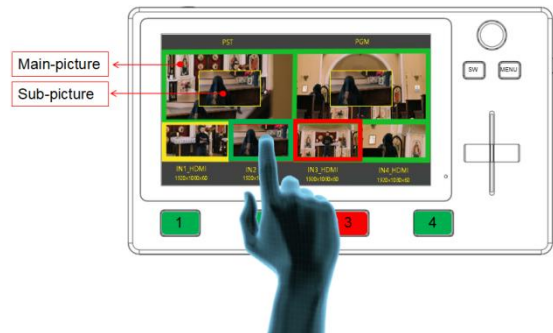

3.3.4 PTZ

L2 PLUS can control cameras which supports VISCA protocol. L2 PLUS allows users to control camera to move, zoom and focus. Meanwhile, it also saves camera position and zoom information for quick retrieval the next time you use it. (L2 PLUS can control up to 8 cameras)

1. Enable the PTZ camera and set the IP of the camera you want to control to the corresponding IP address. (the IP address of camera should be in the same network segment with that of L2 PLUS)

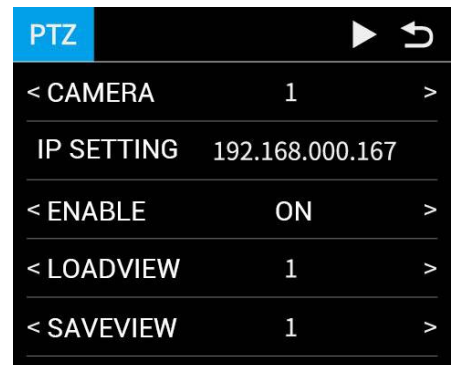

2. you can control PTZ camera's position, zoom and focus as shown in the right picture.



Note: When operating the camera, L2 PLUS needs to remain in the Control interface, otherwise the PTZ camera cannot be controlled.

3.3.5 LOGO Overlay

Enable the LOGO overlay and adjust the position (If it is the first time to set LOGO, please refer to <5.2.17 LOGO>and import the picture in the software.

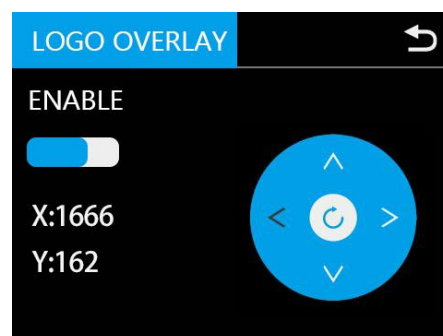

3.3.6 Chroma Key

1. Enable the Chroma key
 2. Select the base color you want to remove, there are 6 kinds of colors you can select: orange, yellow, green, cyan, blue and purple.
- Adjust color in the range of MAX, MIN and MARGIN.



Note: When using chroma key, make sure that the layer you want to edit is on the top layer, which is the B layer in the PIP setting, otherwise you may not see the chromakey effect.

3.4 Switch Source

When you access the four source buttons, the lights on the source buttons will appear in four states:

green constant: the signal is recognized, no action is being taken;

green flashing: the currently selected, signal is being edited;

red constant: the signal is currently on the main output;

unlit: the source is not accessed or the resolution of the accessed source is not supported by the L2 PLUS

After transition effect (MIX) and transition mode (MODE) is selected

In FAST+Time Mode:

1. Press a source button (1, 2, 3, or 4) that is green.
2. Selected source will be switched to the output with the set fade TIME and using the MIX transition selected, with the pressed source button becoming red.

Slide the T-BAR to switch

1. Press a source button (1, 2, 3, or 4) that is green.
2. Slide T-Bar from top end to bottom end or reversely.

Note: Source selection is **locked** when T-BAR is **in transition** (not entirely docked at a top or bottom position)

Chapter 4 Streaming

4.1 OBS Streaming

Video Capture

L2 PLUS is compatible with many third party steaming software, we recommend OBS, which is available to download on <https://obsproject.com/download>. Download the software and update to the latest version.

1. Click "+" icon
2. Choose video capture device
3. Click video capture device to open up setting page
4. Choose: FEELWORLD USB 3.0 Capture
5. Choose Video Format YUY2

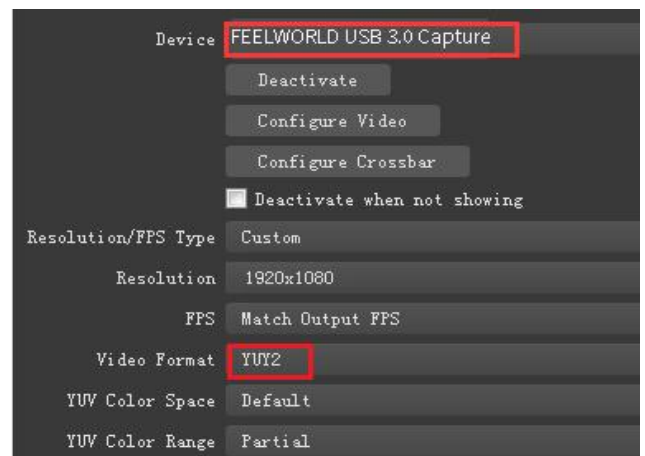
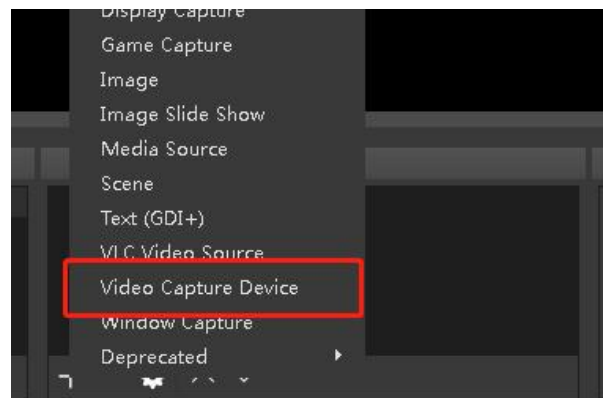
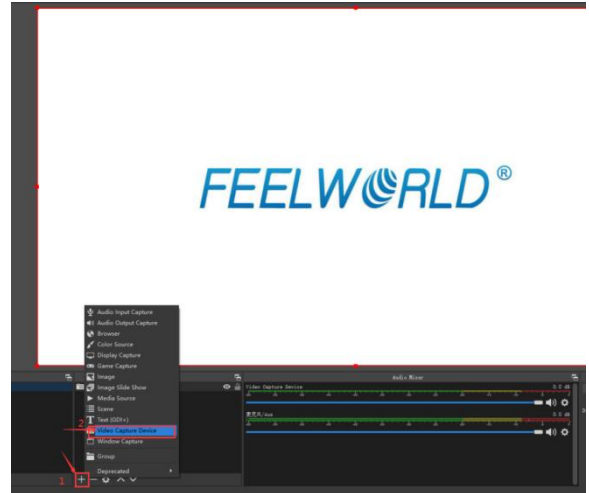

Note: If there is no video format YUY 2 after setting above, check the USB 3.0 port connection. Make sure it is linked to USB 3.0port on PC by USB 3.0 cable. (USB 3.0 cable or port is standard in blue while USB 2.0 is in black). If the captured , change the video format to YUY2.

Audio Setting

When there is no audio playing first check the video source see if the it is set in default value and then check the audio setting on OBS.

1. Set Default for the audio source.

2. Audio setting on OBS.

Choose Audio, click Setting and choose audio device (Mic/Auxiliary Audio Device)

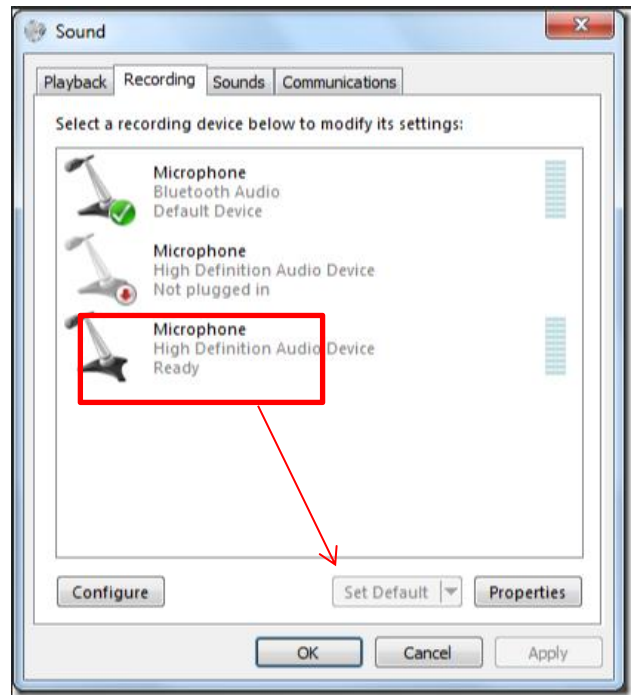

Synchronize Video with External Audio

When the video itself doesn't have embedded audio and need insert external audio. Here are the steps.

1. Set the audio source

Setting → Audio → Mic/Auxiliary Audio Devices

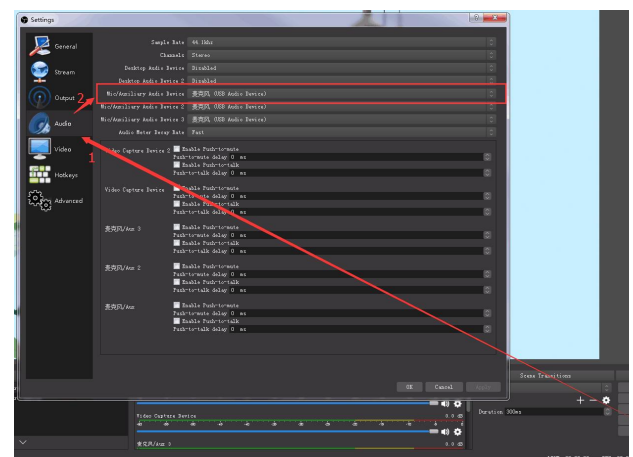

2. Right click the Video Capture Device in Source and choose Filter

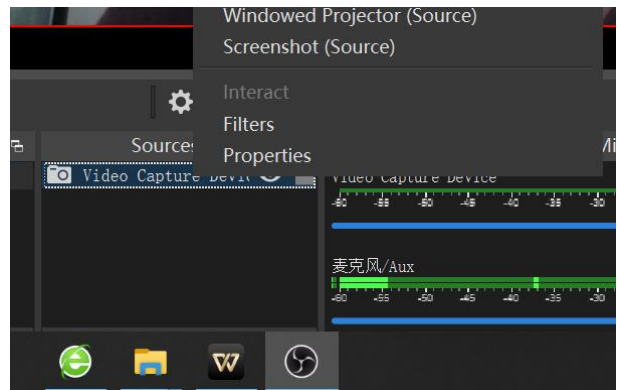

3. Click "+" under Audio/Video Filters and choose Video Delay (Async)

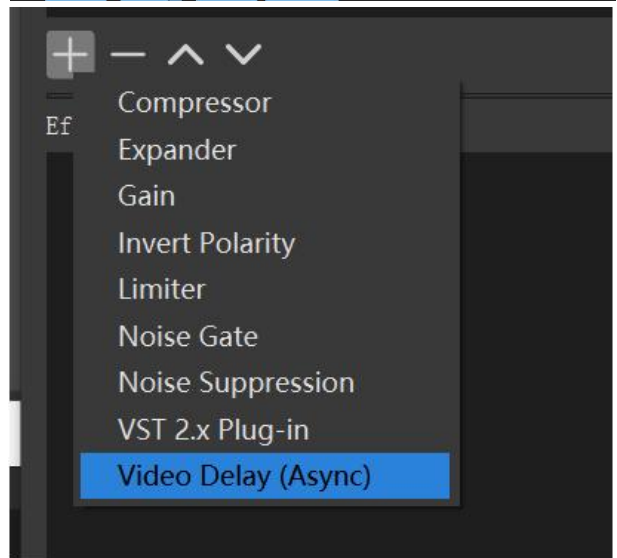

4. You can custom the filter name in the pop-up window. Click OK to confirm the filter name.

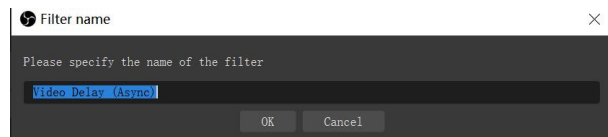

5. Input delay value in ms, the value need to adjusted until the video and audio is synchronous.



Streaming Setting

1. Find the RTMP URL and Stream Key provided by streaming broadcast website.
2. Copy URL and Stream Key
3. Back to OBS, click Setting in the lower right corner and click "Stream". Choose Stream Type as "Streaming Service" or "Custom Streaming Server" . If choose "Streaming Service", there is a list of streaming service name available in the drop down list of Service. If the streaming service is in the list, choose it from the list.
If choose Custom Service, just fill in URL and Stream Key.
4. Paste the RMTMP URL to Server or URL and Stream Key to Stream Key.
5. Click "Start Streaming".
6. Go back to live broadcast website and check the broadcasting.

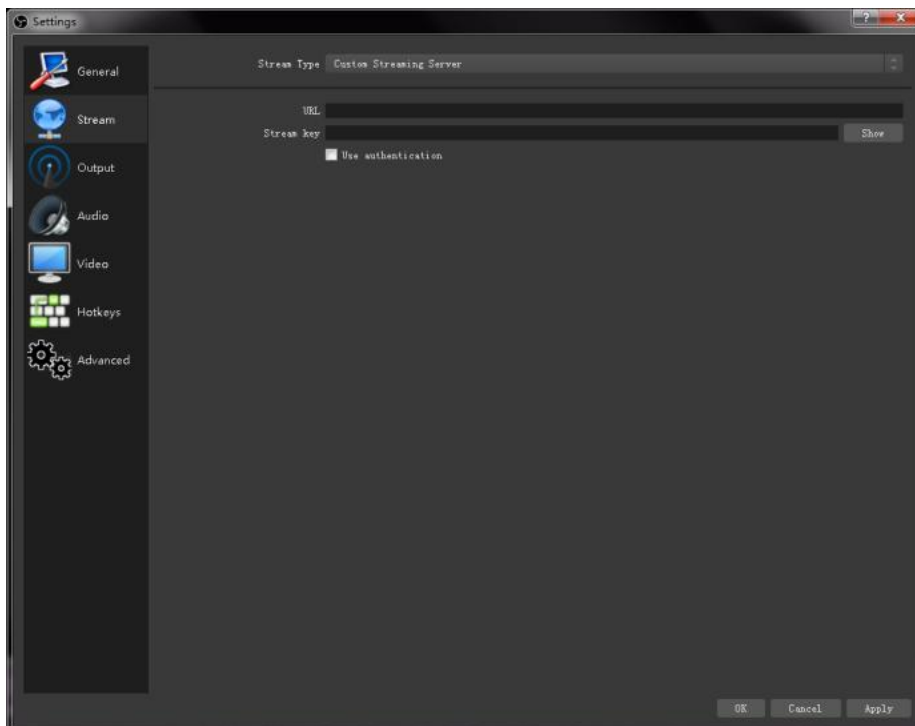
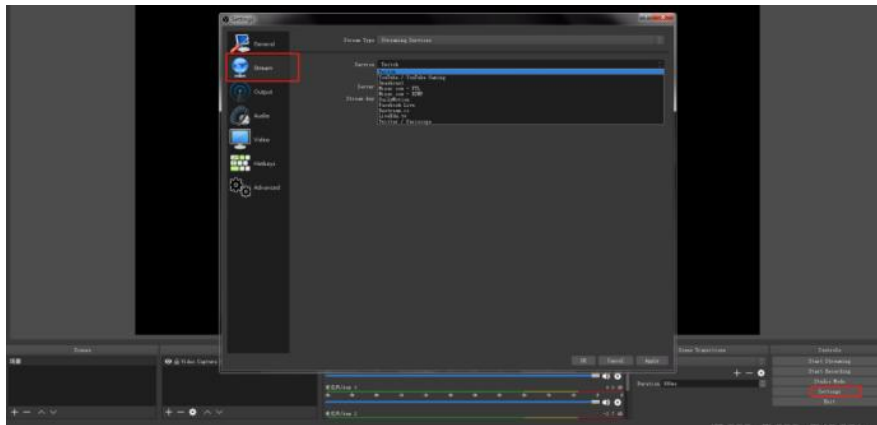

4.2 vMix Streaming

L2 PLUS streaming via vMix steps are as follow:

1. Click a new blank, then click the “Add Input”

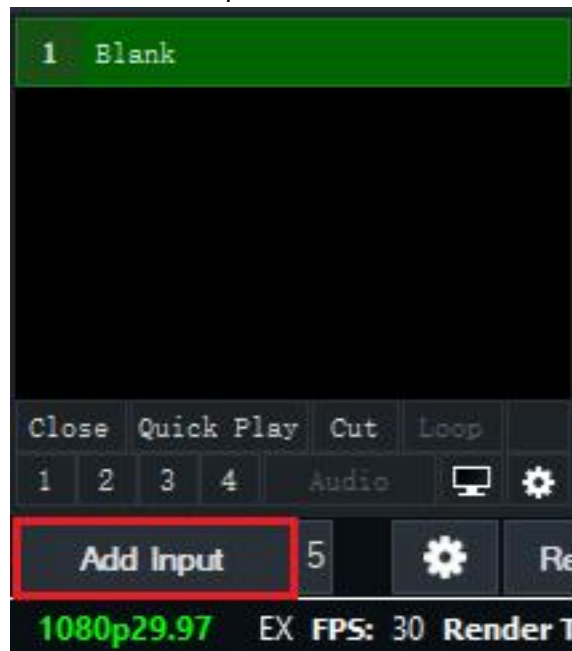

2. Select Camera-Camera-FEELWORLD USB3.0 Capture.

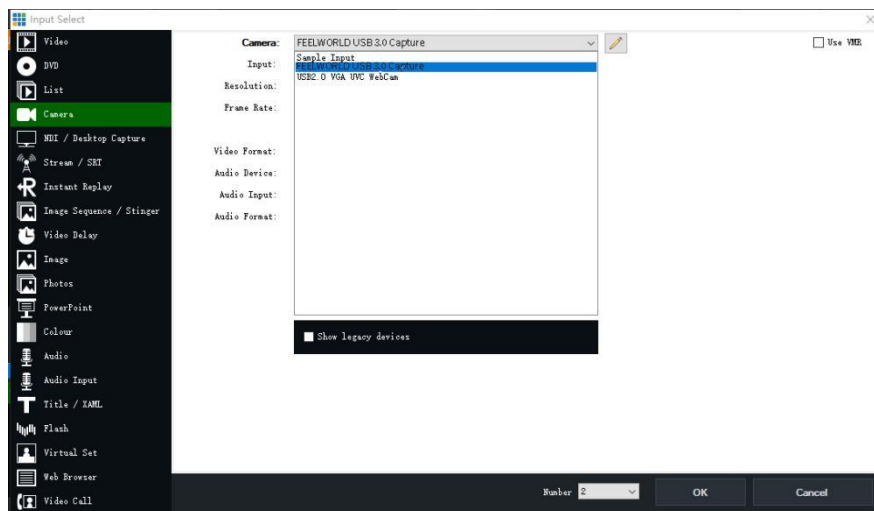

3. Select the same resolution as the L2 PLUS output. Then click “OK”.

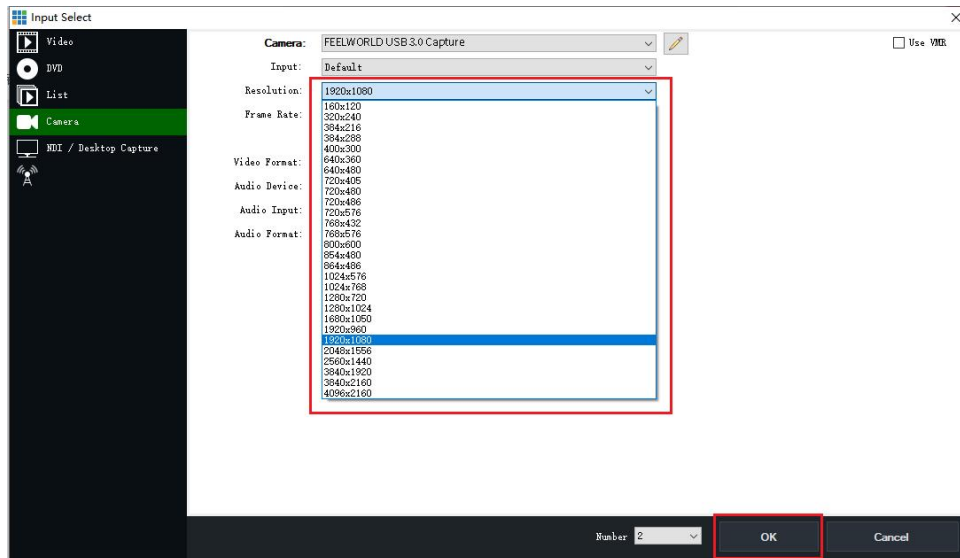

4. Click “Stream” setting button.

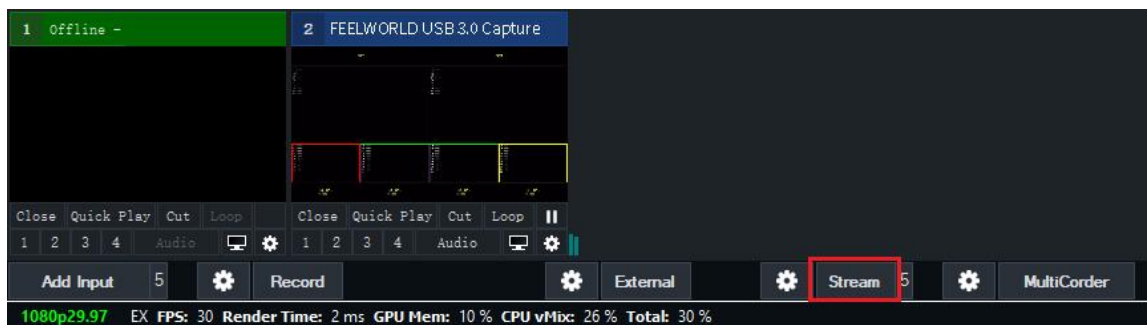

5. Complete the URL and Key information. Click “Start 1”, vMix will begin streaming.

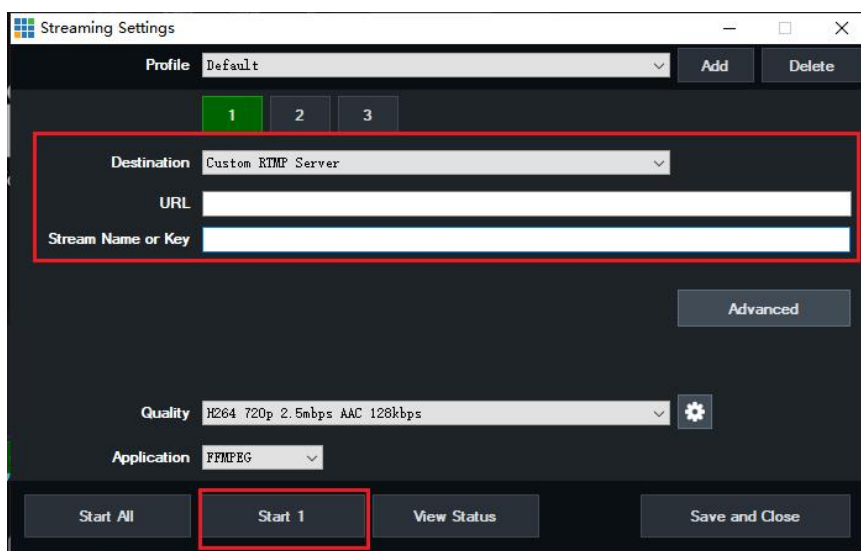

Note: vMix does not support automatic recognition of the output resolution of L2 PLUS. Every time the output resolution of L2 PLUS is modified, the picture on vMix will pause. The user needs to re-select FEELWORLD USB3.0 Capture and manually input the current output resolution of L2 PLUS.

Chapter 5 Feelworld Live Software Operation

Minimum System Requirements for macOS

- macOS 11.0 Big Sur or later
- macOS 10.15 Catalina

Minimum System Requirements for Windows

- Microsoft Windows 10 64-bit

Note: The IP address of the L2 PLUS must be in the same WLAN segment as the computer or the mobile control device you choose.

5.1 Connect L2 PLUS and computer

5.1.1 Direct Link via a Network Cable

(1) Modify L2 PLUS's IP Address

The L2 PLUS is connected to a computer via TCP/IP protocol for data transfer. Therefore, you need to keep the L2 PLUS on the same IP network segment as your PC or mobile device. If the L2 PLUS is connected directly to a computer, you need to change the L2 PLUS's IP manually to avoid IP conflicts on the same network segment.

Steps to modify L2 PLUS's IP address:

1. Push **【MENU】** button and enter IP setting menu.
2. Turn **OFF** DHCP
3. Adjust the value of IP via the knob.

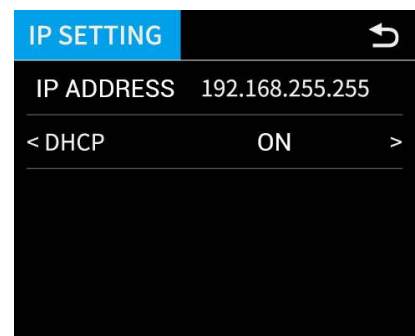

(2) Change the PC's IP Address

To ensure that the L2 PLUS and the PC can communicate smoothly, the IP address of the computer needs to be verified.

Steps to modify the IP address of the Ethernet port (windows).

1. Open the "Network and Sharing Center";
2. Click on "Internet";
3. Access to Properties may require administrator privileges;
4. Under "This connection uses the following items", find "Internet Protocol version 4 (TCP/IPv4)";
5. Select "Use the following IP address" and change the IP address to the same network segment as L2 PLUS, eg: L2 PLUS's IP address is 192.168.0.99, then the computer's IP address can be set to 192.168.0.1-255. Please make sure that the IP addresses do not conflict.
6. Click "Subnet Mask" and the computer will automatically calculate the subnet mask of the address;
7. Click OK.

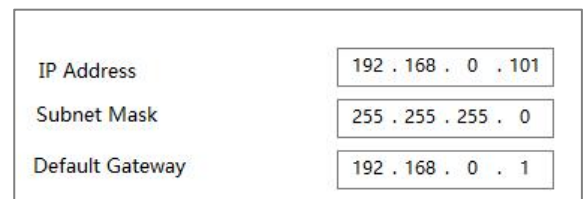
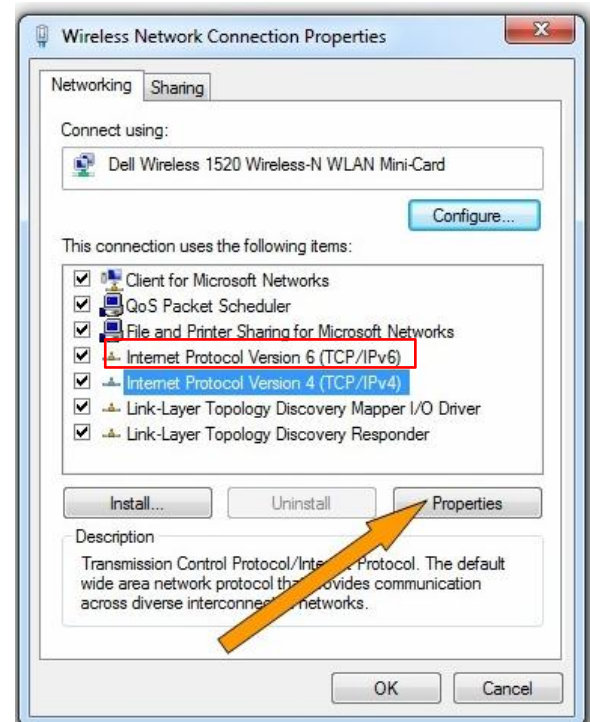
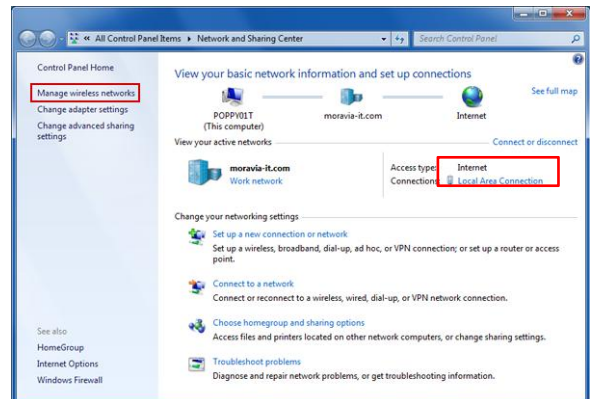

5.1.2 Static Direct Connection

To ensure that Feelworld Live can connect in different classes of subnet masks, if you find that you cannot connect to the L2 PLUS series by searching, please try to use the direct connection method. The direct connection feature was added after Feelworld Live was updated to version V1.0.0.9.

1. Open Feelworld Live and click on the icon in the upper right corner .

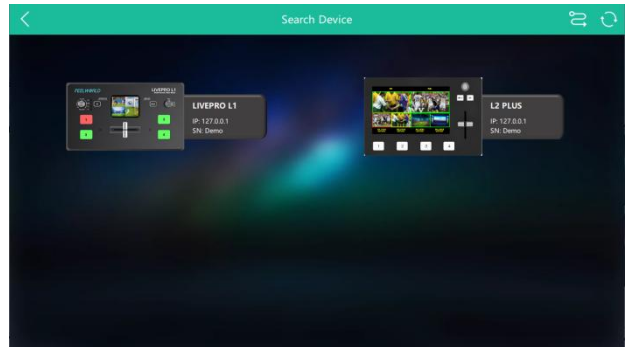

2. Fill in the IP address of the currently connected L2 PLUS.

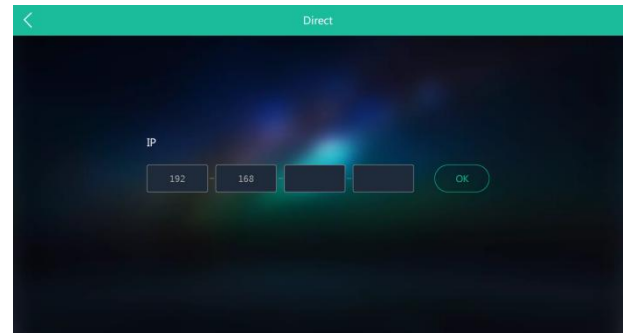

5.1.3 Connect Wirelessly with Your Router

The L2 PLUS provides wireless control, so you can control it from a greater distance when the L2 PLUS is not in your immediate vicinity. A wireless router is required to use this feature. The computer receives the wi-fi signal from the wireless router you connect the L2 PLUS to.

Steps of wireless connection:

1. Connect the L2 PLUS to the router's LAN port.
2. Press the **【MENU】** button and enter the IP settings sub-menu.
3. Turn on the DHCP switch.
4. Computer connects to Wi-Fi from the router.
6. Open Feelworld Live to search the device.

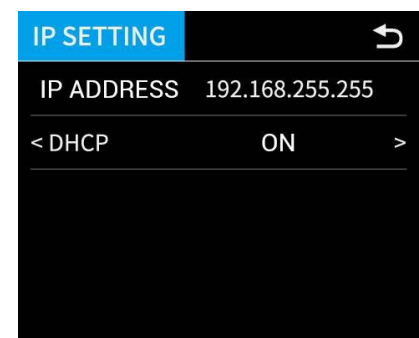

5.2 Using Feelworld Live

Feelworld Live software simulates the L2 PLUS's real world appearance and the operations you can control with Feelworld Live are very similar to those you can do with the L2 PLUS's hardware. You can use this button for functions that are not possible with the L2 PLUS hardware.

Note:The Android and IOS versions can only connect wirelessly. Regardless of whether you are using wireless or wired, you need to make sure that the IP addresses are on the same network segment and that they do not conflict.

After software is installed, click the icon  and click Search to search L2 PLUS device.

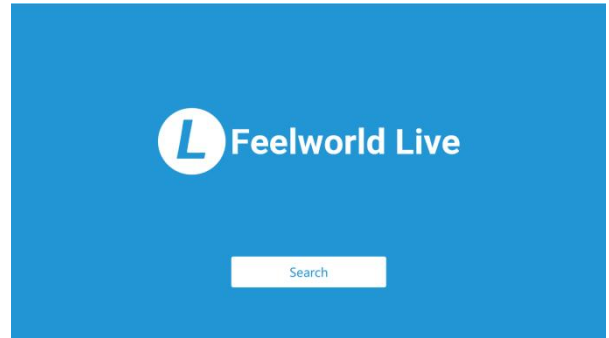

After searching, all available L2 PLUS devices in the sub-net can be found, up to 128 devices can be found if there are.

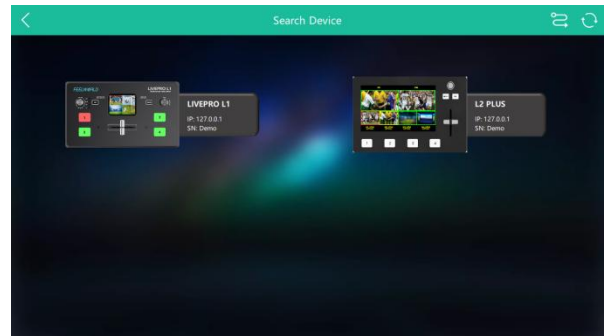

Select the desired device by SN and IP and enter the management interface. The software interface is a simulation of operation panel on real L2 PLUS device.

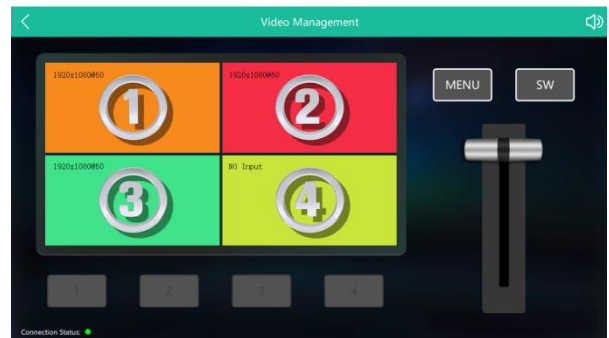

For example, clicking Button MENU  can open up menu as on the device. If it is the first time for you to use Feelworld Live, we suggest you watch our User Guide video.

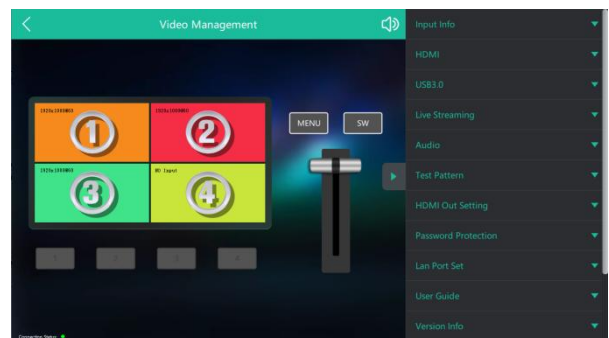

5.2.1 Input Info

In the **【Input Info】** you can check the input resolution

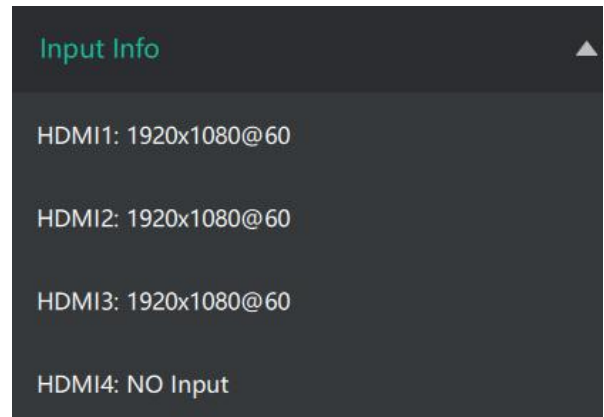

5.2.2 HDMI

Output: PVW/PGM

Format: 1920 × 1080@60(max)

Click<**Set**>after confirm

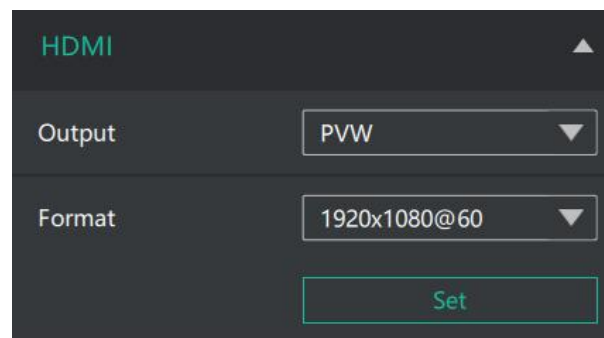

5.2.3 USB 3.0

Output: PVW/PGM

Format: 1920 × 1080@60(max)

Click<**Set**>after confirm

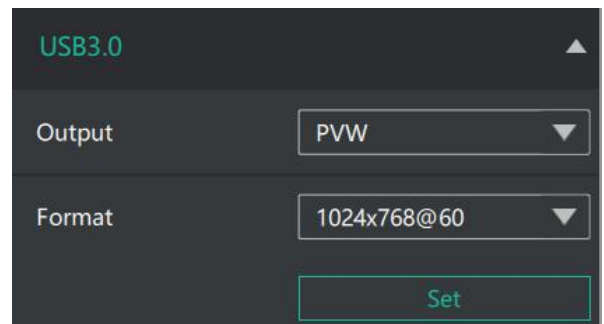

5.2.4 Live Streaming

Device Capture: choose FEELWORLD USB3.0 Capture

H.265: When it is ON, users can watch 4 inputs streaming back on XPOSE software.

Import the related OBS application if users need to do live streaming, click Relate to confirm.

OBS: slide ON to start streaming.

Note: H.265 and OBS cannot work at the same time. User choose either H.265 or OBS, not both.

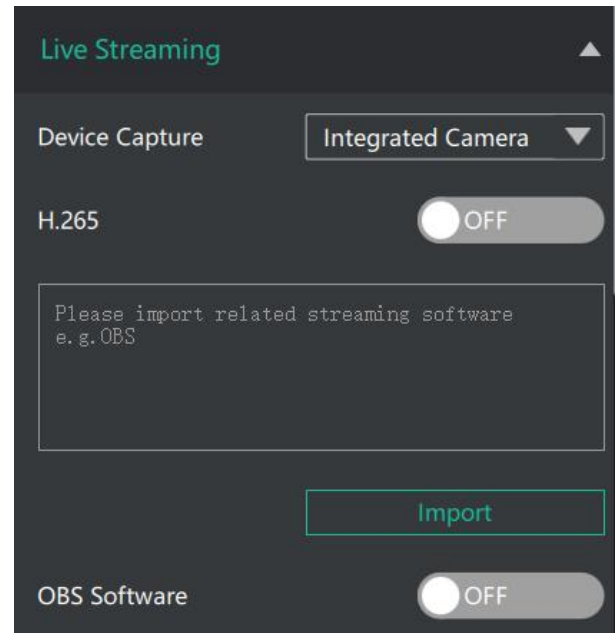

5.2.5 Audio

Main Audio: AFV/HDMI 1~4/MIC/LINE

Mix Audio: OFF/HDMI 1~4/MIC/LINE

MIC/LINE: LINE/MIC

Audio Bar: ON/OFF

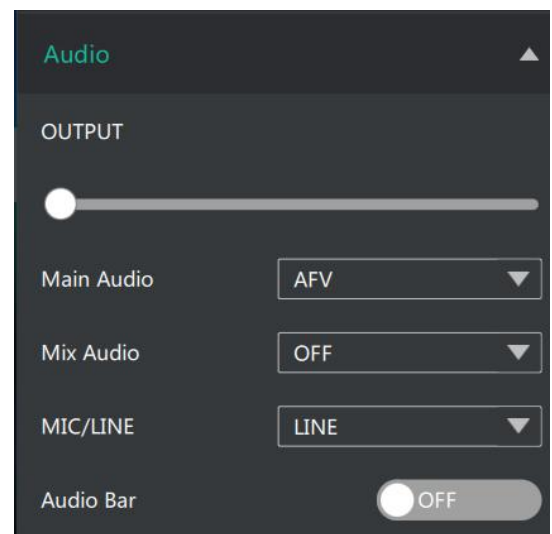

5.2.6 Test Pattern

To facilitate troubleshooting, Feelworld Live provides a test signal output, which can be used to troubleshoot the USB or HDMI output interface when there is no output signal from USB or HDMI.

Output: Select the USB/HDMI interface to be tested.

Test Pattern: Select the mode of the test pattern.

Color: Adjust color.

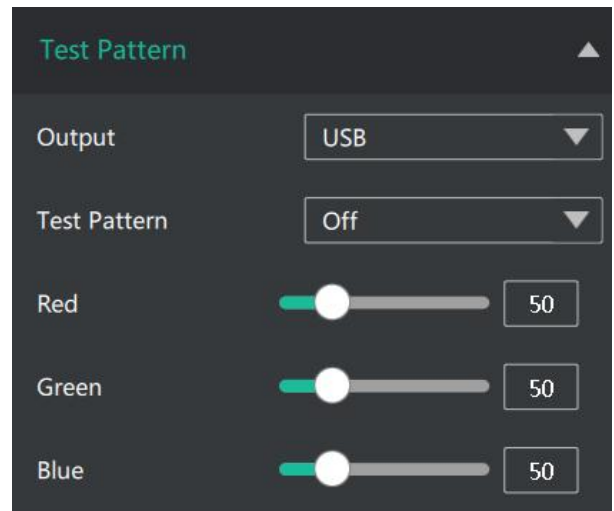

5.2.7 HDMI Out Setting

HDMI: HDMI/DVI

Bits: 8/10/12 bit

Color Space: Image/Video

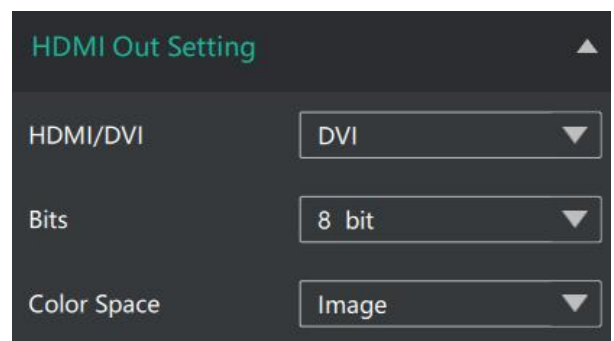

5.2.8 Password Protection

In order to solve the problem of control conflicts caused by different devices controlling the same L2 PLUS in the same LAN, Feelworld Live provides a password protection function, as an administrator, you can set a password for the device controlling Feelworld Live, and when you control the interface again, you need to enter the password to control it.

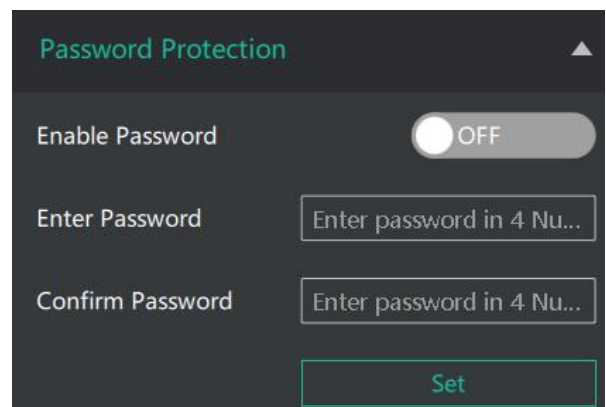

Note: If you have forgotten your password, please restore the factory settings on the L2 PLUS

5.2.9 Lan Port Set

In **【Lan Port Set】**, you can check current IP, mask and gateway.

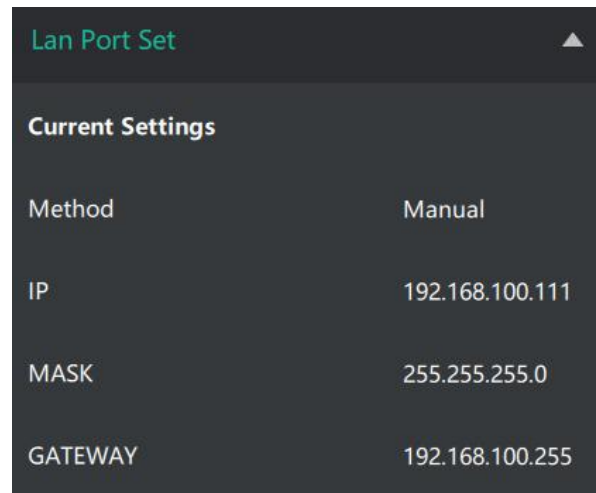

If you want to change the IP address,mask and gateway, turn **off DHCP** first and change the value.

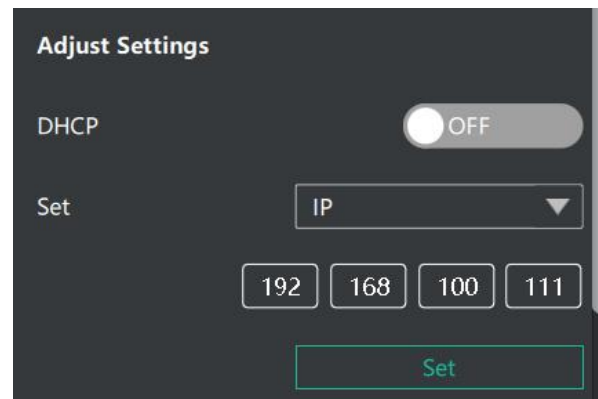

5.2.10 Language

There are 5 kinds of language: Chinese, English, Russian, German and Korean.

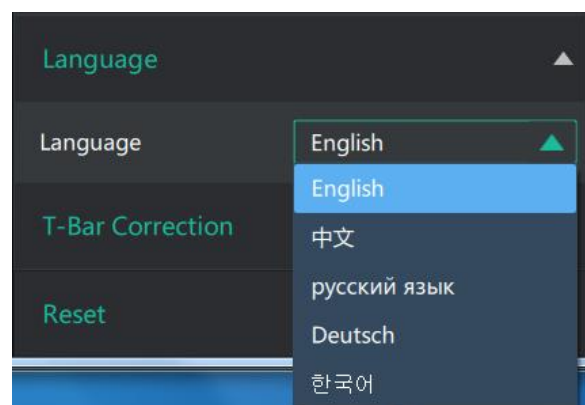

5.2.11 T-Bar Calibration

If the T-Bar is not in the correct position, no other operation is possible. T-Bar correction is available in Feelworld Live.

The steps are as follow:

1. Turn on the T-Bar Calibration switch.
2. Push the T-Bar to the **top side** on the L2 PLUS.
3. Turn on the "On" switch
4. Push the T-Bar to the **bottom side** on the L2 PLUS.
5. Turn on the "On" switch

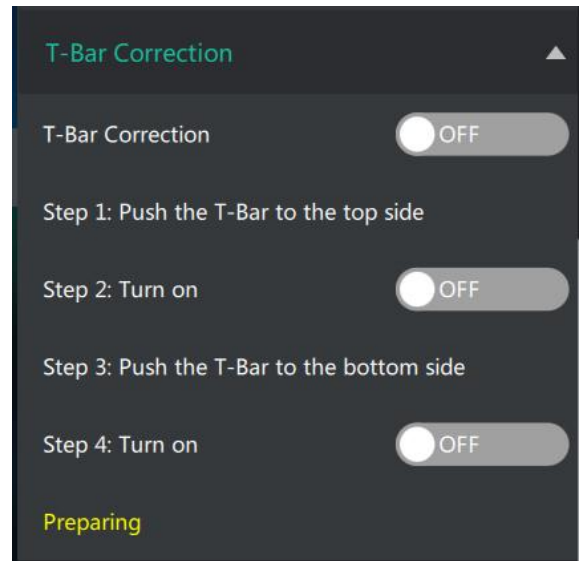

5.2.12 Reset

Reset will remove all settings.



5.2.13 MIX

Mode: Fast/T-Bar

Time: 0.5s~5.0s

Layout: 15 kinds

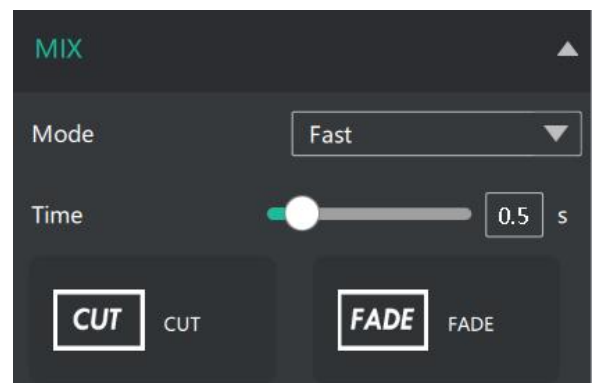

5.2.14 PIP

There are 9 kinds of PIP layout

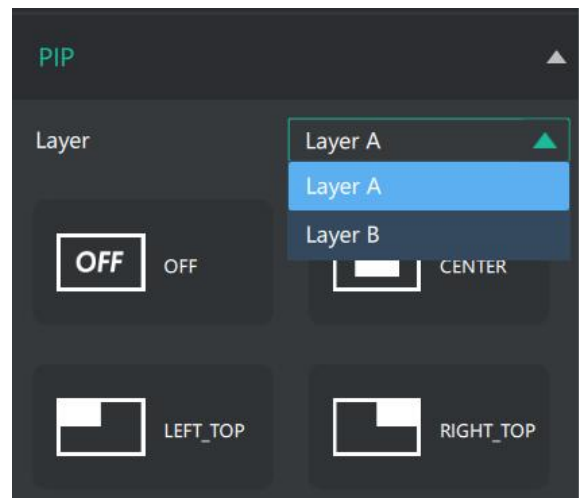

5.2.15 Chroma Key

1. Select the base color you want to remove, there are 6 kinds of colors you can select: orange, yellow, green, cyan, blue and purple.
2. Adjust color in the range of MAX, MIN and MARGIN. You can click in the MAX MIN MARGIN data input box to achieve a more precise keying effect.

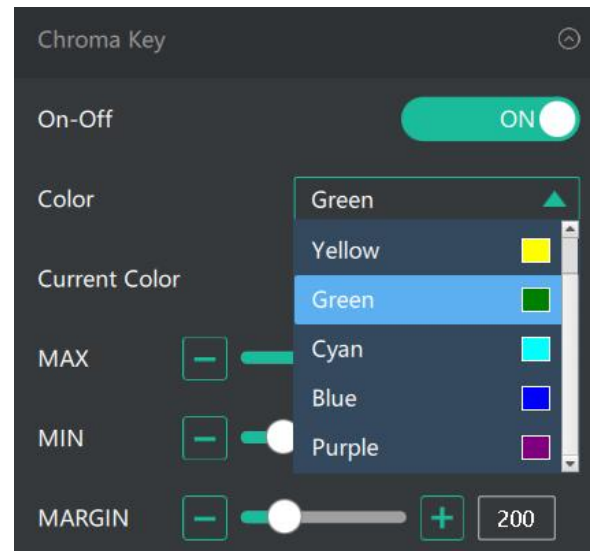

Note: When using chroma key, make sure that the layer you want to edit is on the top layer, which is the B layer in the PIP setting, otherwise you may not see the chromakey effect.

5.2.16 PTZ Camera Setting

When controlling the PTZ camera, the computer, L2 PLUS and PTZ camera should be in the same network segment.

1. Set the corresponding communication port on the PTZ camera, such as VISCA or UDP port 1259.

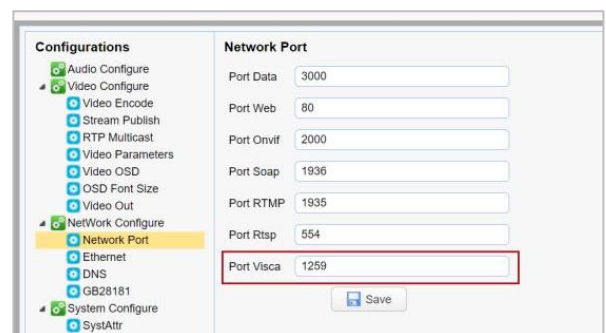

2. Set both old IP and new IP to the camera IP address you want to control, the corresponding communication port to 1259 on L2 PLUS, configuration path: SW → FX → PTZ Camera Setting Port on the control software of L2 PLUS.



3. After IP address setting, turn on **【Enable】** and you can control PTZ camera. You can click and set camera to zoom and focus. Turn on **【Auto】**, the camera will zoom and focus automatically. You can slide the bar to adjust brightness. You can also slide to set Pan/Tilt speed of camera. Click to set camera's rotation position.

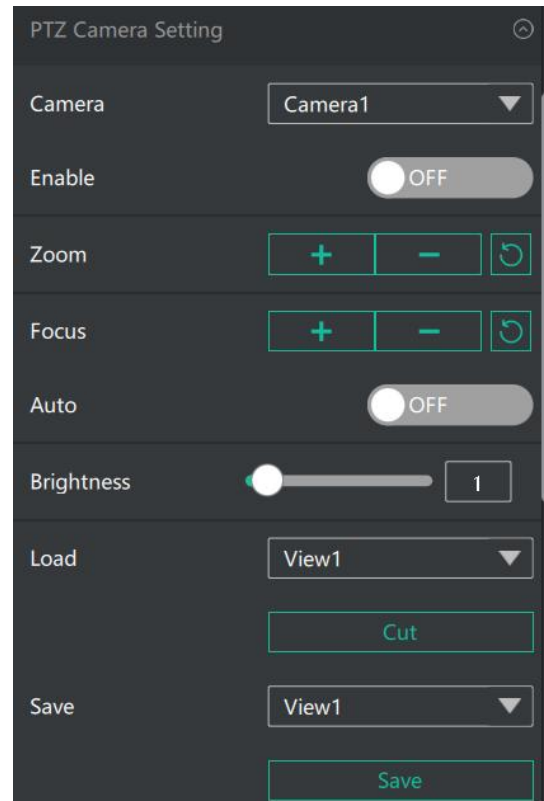

5.2.17 Logo Overlay

If it is your first time to use Logo Overlay, please connect L2 PLUS to your computer, and make sure that IP address of both are in the same network segment.

1. Select a picture as the Logo.
2. Click "ColorPicker" and select color you want to filter in the LOGO picture, and current color can be seen below.
3. Turn on "Transparent Switch", the filtered color will disappear in the LOGO picture.

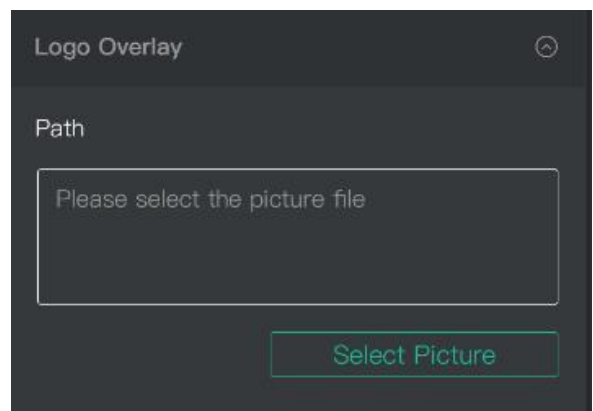

4. Click “Logo Generated”, “upgrading” will be seen in the TFT screen of L2 PLUS, and the Logo picture will be imported in.

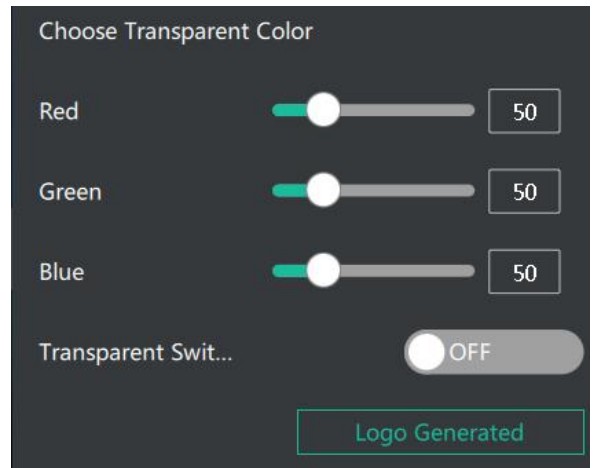

Note: The format of the LOGO image should be BMP 24 bits, and the image size should be within 256*128 pixels.

Chapter 6 Product Parameters

Screen	5.5-inch (touch)		
Connections	Input	HDMI In	4×HMDI
	Out	HDMI Out	1×HMDI
		USB3.0	1×USB TypeA
	Audio	IN	1×3.5mm (MIC)
		OUT	1×3.5mm (LINE)
	Communication	LAN	1×RJ45
Power		1×DC Jack	
Performance	Input Resolutions	HDMI SMPTE:720p@50/60 1080i@50/60 1080p@23/24/30/50/60 VESA:1024X768@60 1280X720@60 1280X768@60 1280X1024@60 1360X768@60 1366X768@60 1440X900@60 1600X1200@60 1680X1050@60 1920X1080@60 1920X 1200@60	
	Output Resolutions	HDMI SMPTE:720p@50/60 1080p@24/25/30/50/60 VESA:1024X768@60 1280X720@60 1280x768@60 1280X1024@60 1360X768@60	
	Supported Standards	HDMI	1.3
		USB	3.0
Power	Input Voltage	DC 12V/2A	
	Max Power	≤ 21W	
Environment	Temperature	-30℃ ~ 50℃	
	Humidity	10%~85%	
Physical	Weight	610g	
	Dimension	191(L) x 110(W) x 43(H)mm	

★ As we are improving product features and product performance, so if there is any change on the specification without prior notice.